

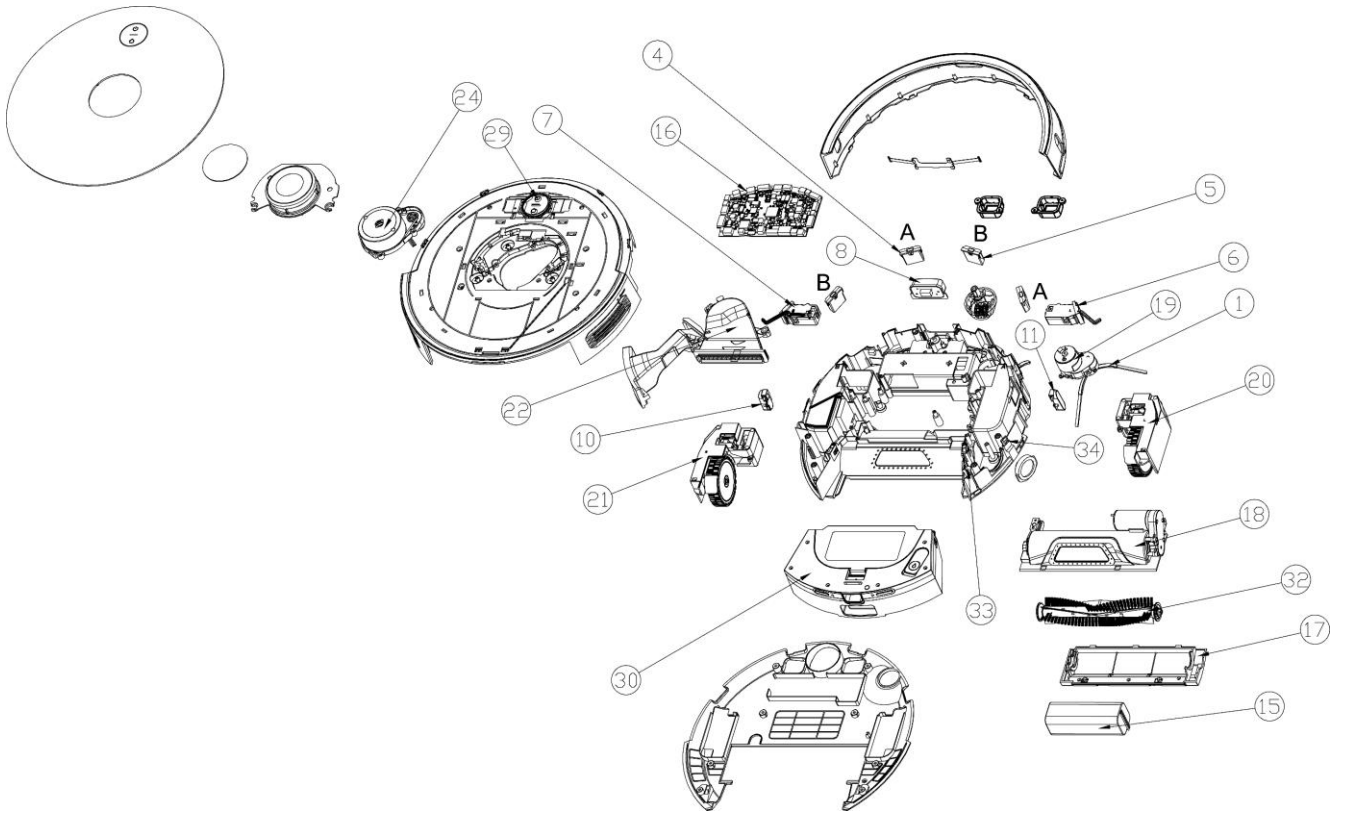



Spare parts list



Main unit



Product picture	Designation	Article number	Exploded view
	Mainboard for robot	017.060	16
	Suction motor for robot	017.061	22
	2D LiDAR sensor	017.062	24

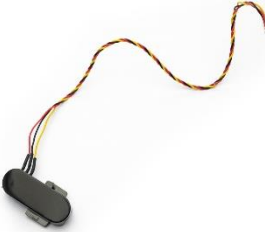

	Lithium-ion battery 14.4V, 5.2Ah	017.064	15
	Touch control unit for robot	017.067	29
	Cover for roller brush	017.068	17
	Cliff sensor (type A)	017.069	4
	Cliff sensor (type B)	017.070	5
	Anti-collision sensor front, infrared	017.071	8
	Antenna for communication module	017.072	k. A.
	Motor assembly for roller brush	017.073	18

	Drive unit (right, incl. wheel)	017.074	21
	Drive unit (left, incl. wheel)	017.075	20
	Dust container	017.076	30
	Motor assembly for side brush	017.077	19
	Cleaning tool brush and knife	017.079	k. A.
	Remote control	017.080	k. A.
	Impact switch (left, for front bumper)	017.083	6

	Impact switch (right, for front bumper)	017.084	7
	Side distance sensor (left, infrared)	017.086	10
	Side distance/wall sensor (right, infrared)	017.087	11
	Magnet sensor for dust box detection	017.089	33
	Reset button	017.088	34
	Communication module	017.090	k. A.

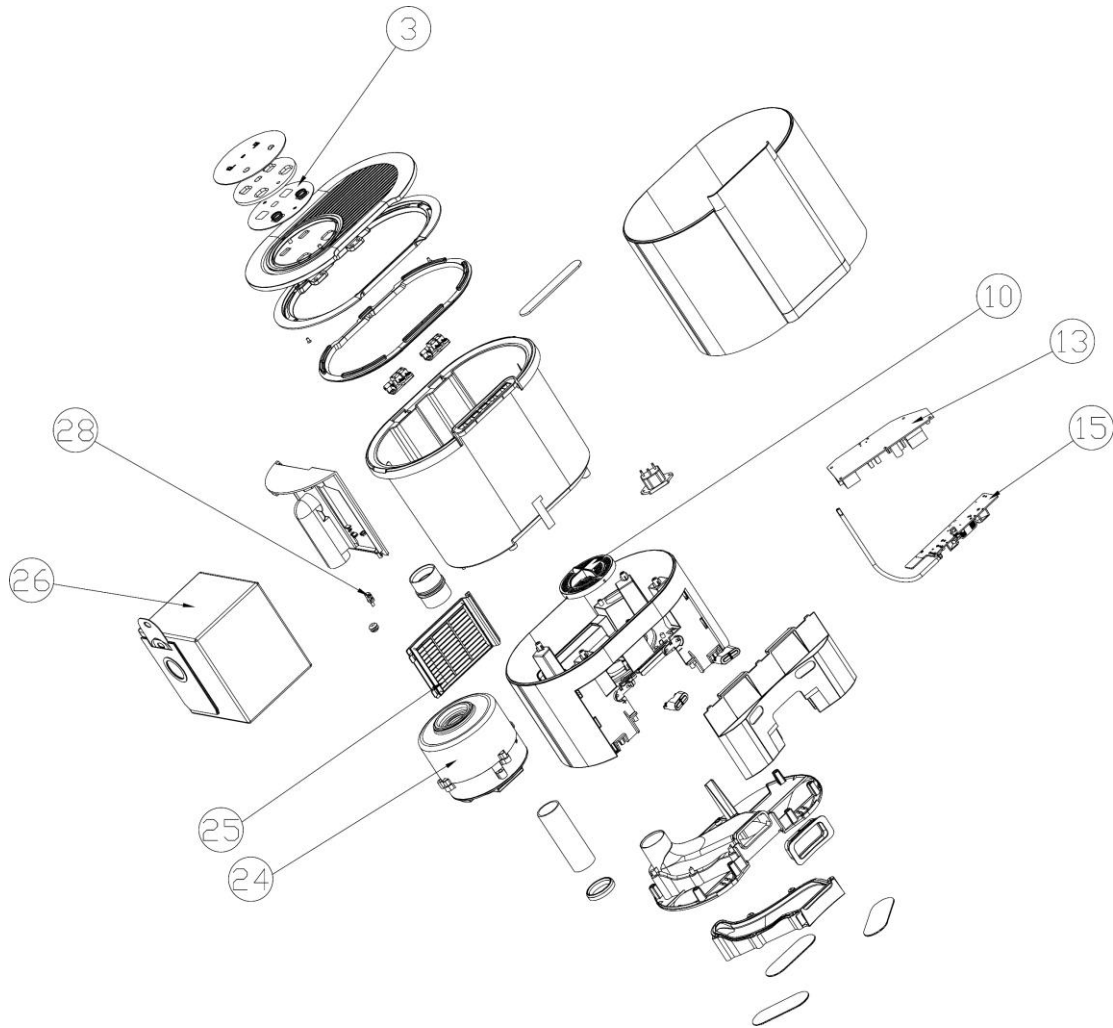
Suction station



Product picture	Designation	Article number	Exploded view
	Power electronics board for suction station	017.063	13
	Mainboard for suction station	017.065	15
	Suction motor for suction station	017.066	24

	Microswitch for dust bag detection	017.078	28
	Touch control unit for suction station	017.081	3
	Suction motor filter	017.082	10
	Carbon filter	017.085	25